

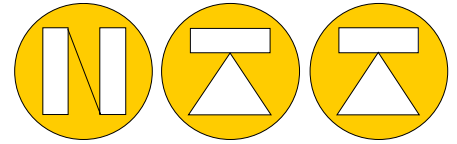

C2S 20t -200t Low profile cell



NORDIC TRANSDUCER

NOW also with amplified output: 4-20mA, 0-5V or 0-10VDC

LOW PROFILE COMPRESSION LOAD CELLS



Capacities from 20ton to 200ton for use in:

- ° Bigger platform scales
- ° Hopper / silo weighing
- ° Other force measuring applications

The C2S is a very low profile hermetically welded sealed load cell made in stainless steel with IP68 protection grade.

Their compact size makes them ideally suited for applications where space also is limited.

UPC3S Silo mount can be supplied for 20 & 30ton capacities

SPECIFICATIONS C2S-126/165/200 2mV/V model Class C2

NOMINAL LOAD	20, 30, 50, 75, 100, 150, 200t	a) minimum load	0%
MINIMUM RANGE	0 - 20%	b) service load	120%
COMBINED ERROR	< +/- 0.023%	c) max. permissible load	150%
NON REPEATABILITY	< +/- 0.010%	d) breaking load	>300%
ZERO DRIFT 30 MIN	< +/- 0.028%	e) max. side load	50%
TEMPERATUR EFFECT 10°C		f) max. dynamic load	50%
on zero	< +/- 0.024 %	NOMINAL TEMP. RANGE	- 10/+40 °C
on span	< +/- 0.017 %	SERVICE TEMP. RANGE	-20/+70 °C
NOMINAL SENSITIVITY +/-0.1%	2mV/Volt	PROTECTION CLASS	IP68
INPUT RESISTANCE	700 Ohm	CELL MATERIAL	Stainless steel
OUTPUT RESISTANCE	700 Ohm	CABLE LENGTH	5/10 meter
ZERO BALANCE	0.5%		
SUPPLY VOLTAGE N.10V	2 - 15 Volt		

PVC 105°C cable Ø6.5mm with 4 tinned conductors Ø0.35mm² and tinned shield. Gravity acceleration g=9.804427 m/s²
Specifications with OIML R60 as reference.

UPC3S SILO MOUNT FOR 20t & 30t CAPACITY LOAD CELLS

This **UPC3S** weighing unit is constructed throughout in (AISI 304) stainless steel, and design to facilitate the installation of weighing and batching systems, in silos, bins and platform scales where 100% control are wanted over mechanical connection to the load cells. This weighing unit is equipped with **Automatic Load Alignment** and **Transverse Shift Compensation** system to ensure **Excellent Measurement Performance** even in case of settling, thermal expansion, positioning error and structural deformations. Each unit comprises a **C2S-126 load cell**.



Nordic Transducer



DIMENSIONS: C2S-126 20 - 30T
C2S-165 50T-100T
C2S-200 150T-200T

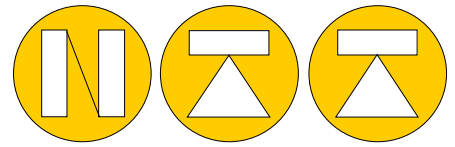

NORDIC TRANSDUCER

Notice:
 50 - 200 ton
 90° 4 holes

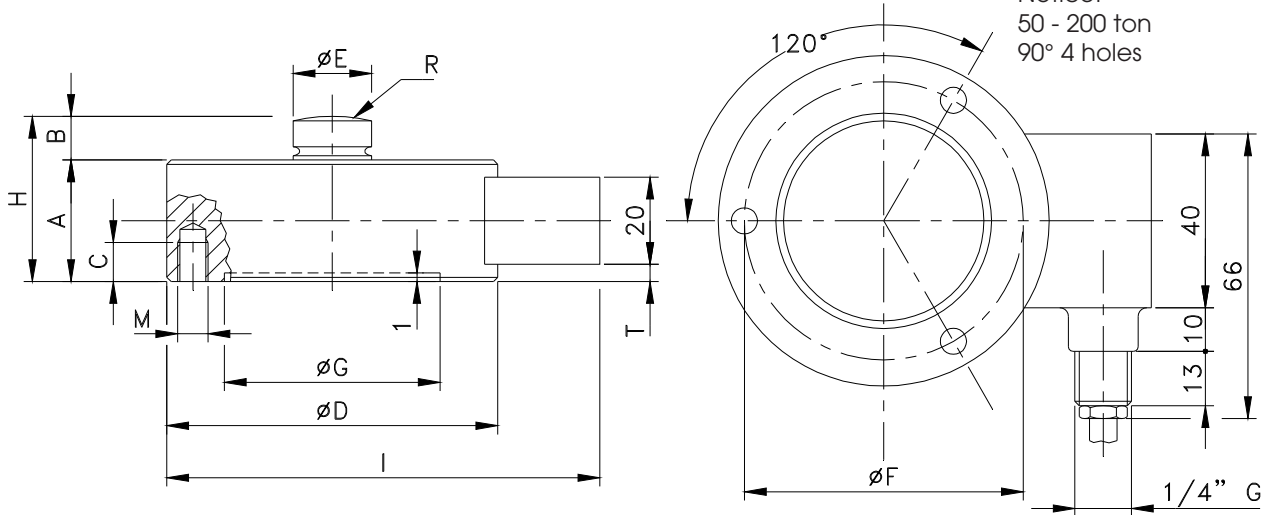

Type Load cell	A	B	C	ØD	ØE	ØF	ØG	H	I	N° HOLES	M	R	T
C2S-126-20-30t	40	14	16	126	35	105	79.5	54	148	3 xM8	8	160	15
C2S-126-20-30t*	50	14	12	126	35	90	77.3	64	148	3 xM8	8	160	15
C2S-165-50-100t	60	20	20	165	60	130	92.3	80	188	4 xM16	16	300	17
C2S-200-150-200t	80	30	20	200	80	152	107	110	223	4 xM16	16	300	23

C2S-126-20-30t* to be used in connection with UPC3S silo mount, and with AMP model

FIXING BOLTS always use **Class 12.9 bolts**

Diameter: M8 M16
 Tightening torque: 80Nm 230Nm

Displacement: 100kg-10t 20-30t 50-100t 150-200t
 mm: 0.06 0.16 0.23 0.36
 Weight kg: 1.3 3.4 9.4 18.2

Load heads

Type	Capacity	ØD	H	ØA	B
TIC35	Ø126 20 & 30t	76	30	36	12
TIC60	Ø165 50t-100t	126	38	61	12
TIC80	Ø200 150-200t	128	42	81	20

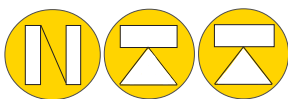
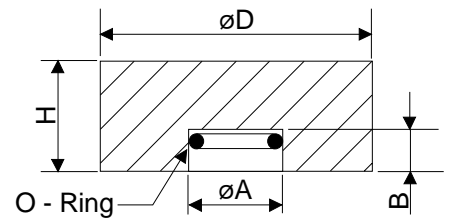

Nordic Transducer

Als Odde, DK-9560 Hadsund Denmark
 tlf. +45 98581444, Fax.: +45 98581866
 E-mail: ntt@ntt.dk WEB: <http://www.ntt.dk>

All specifications subject to change without notice



C2S-AMP Amplified Load cell

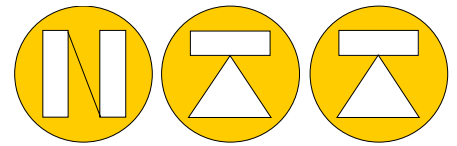

NORDIC TRANSDUCER

INDUSTRIAL STANDARD OUTPUT

4-20mA - 0..5Volt or 0..10Volt 3wire system

The whole range of **C2S** load cells can now also be supplied with internal amplifier for usage at single cells jobs say for testing jobs and the like, for direct connection to PLC

The accuracy for the AMP model is:

+/- 0.03% Non Linearity,

+/- 0.01% Non Repeatability

Calibration tolerance is +/-0.1%

Nominal power supply is 12-24Vdc max. 28 Volt

Max. absorption is 30mA (without load applied)

A 5 point test report can also be supplied as a option at order time.

C2S-AMP can be supplied with cable or connector.



LOAD CELL STANDARD CABLE 2mV/V

INPUT+ RED

INPUT- BLACK

OUTPUT+ WHITE

OUTPUT- YELLOW

SHIELD: Not connected to load cell

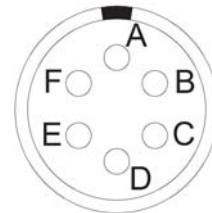
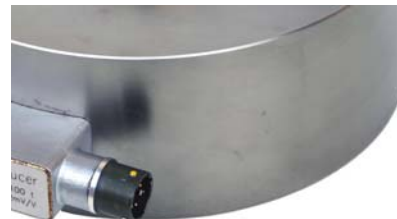

AMP Mill connector for 4-20mA output:

Power supply 12-24VDC = A (RED)

0V/ -Signal = B (BLACK)

Signal Output + = D (WHITE)

Earth / shield = F connected to Body

Picture seen from soldering side

AMP

If supplied with Connector & mounted with cable, the cable length is 5m as standard.



Nordic Transducer

Als Odde, DK-9560 Hadsund Denmark

tlf. +45 98581444, Fax.: +45 98581866

E-mail: ntt@ntt.dk WEB: <http://www.ntt.dk>